

OVERALL HEIGHT = 118.5"
OVERALL WIDTH WITH RUB
RAILS & FENDERETTES = 98"

POWER ARC LIGHT BAR- LED-XTT76LB-RWRRWR-FF6

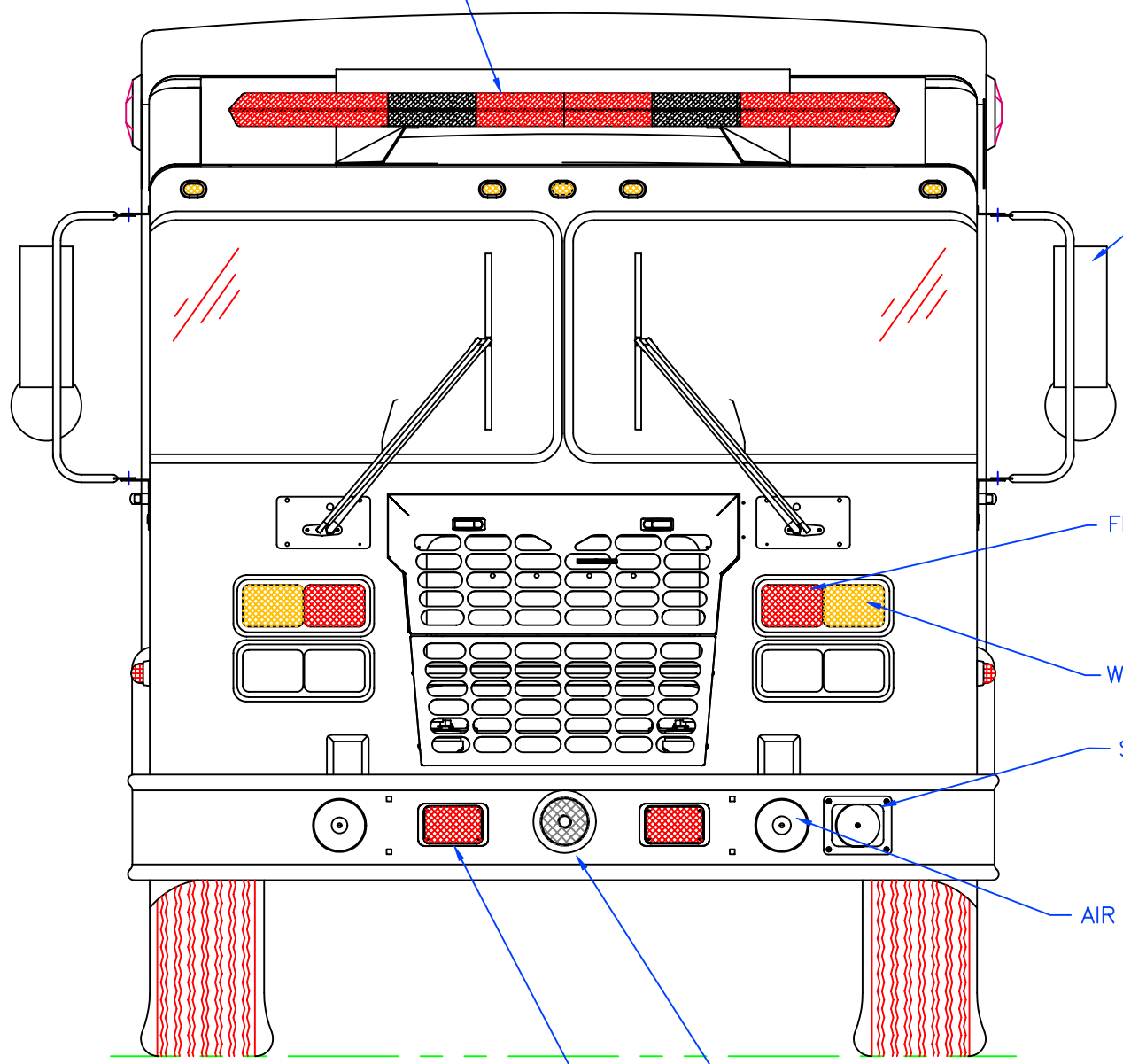

MOTO-MIRROR PLUS

FEDERAL 4x6 RED QUADRAFLARE

WHELEN 600 LED TURN SIGNAL

SIREN SPEAKERS

AIR HORNS

SCREAMING EAGLE SIREN

FEDERAL 4x6 RED QUADRAFLARE



2010 FRONT EXTERIOR VIEW
SUPER CHIEF METRO

1:18

| | | |
|-------|----------|------|
| DATE: | 4 JAN 10 | |
| DWG. | TKD | REV. |
| | | NR |

DRAWING NO.
MSSC-1

OVERALL HEIGHT = 118.5"
OVERALL WIDTH WITH RUB
RAILS & FENDERETTES = 98"

WHELEN 4500 SERIES REAR LIGHT BAR W/BRAKE
700 SERIES LED LIGHTS WITH 700 SERIES HALOGEN LOAD LIGHTS
RED/RED/RED/LOAD/AMBER/LOAD/RED/RED/RED

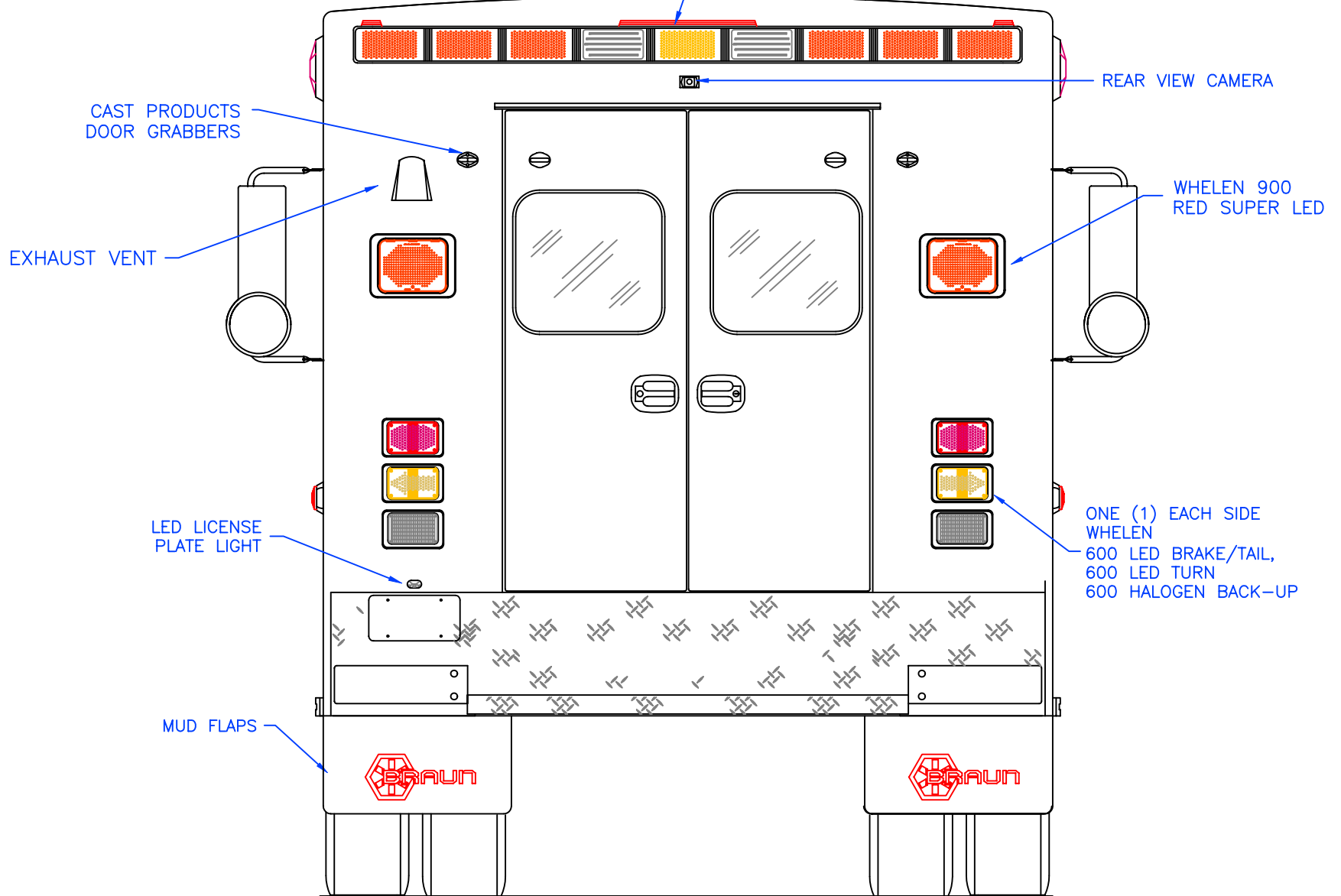

2010 REAR EXTERIOR VIEW
SUPER CHIEF METRO

1:18

DATE:
4 JAN 09
DWG. REV.
TKD NR

DRAWING NO.
MSSC-2

OVERALL HEIGHT = 118.5"
 OVERALL LENGTH = 317" APPROX.
 MODULE LENGTH = 191"

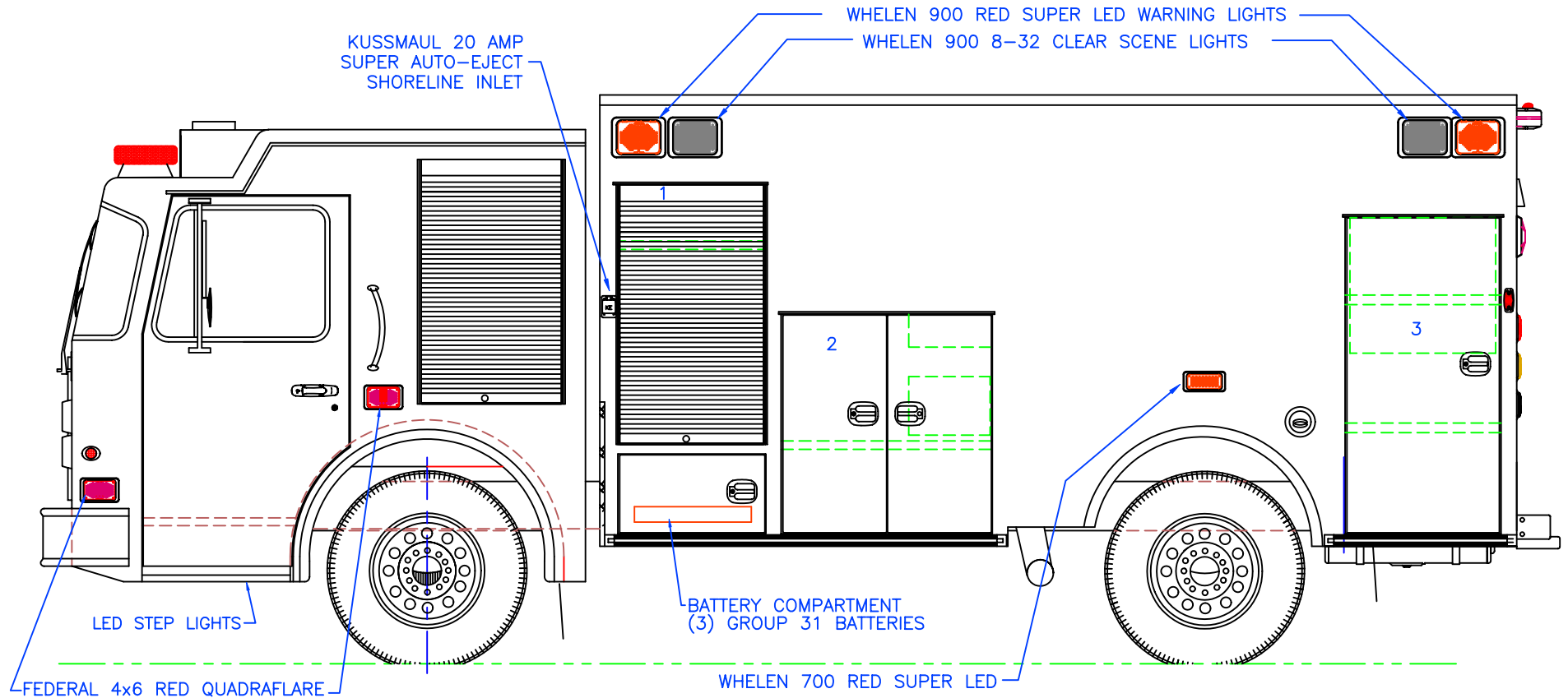

COMPARTMENT
 CAB ROLL-UP COMPARTMENT
 CLEAR OPENING: 51.00h x 30.00w
 TRANSVERSE COMPARTMENT

O.S.S #1
 CLEAR OPENING: 53.75h x 30.00w
 INSIDE DIM'S.: 58.125h x 30.00w x 21.75d
 TRANSVERSE BACKBOARD STORAGE
 ONE (1) ADJUSTABLE SHELF

O.S.S #2
 CLEAR OPENING: 40.25h x 38.25w
 INSIDE DIM'S.: 43.50h x 43.75w x 21.75d
 ONE (1) ADJUSTABLE SHELF

O.S.S #3
 CLEAR OPENING: 63.50h x 29.50w
 INSIDE DIM'S.: 65.25h x 32.75w x 21.75d
 INSIDE/OUTSIDE ACCESS
 TWO (2) ADJUSTABLE SHELVES

DIMENSIONS ARE NOMINAL



2010 STREETSIDE EXTERIOR VIEW
 SUPER CHIEF METRO

| | | | |
|-------------------|-----------|-----------------------|--|
| DATE: 4 JAN 10 | | DRAWING NO. MSSC-3 | |
| DWG. TKD | REV NR | 1:30 | |

OVERALL HEIGHT = 118.5"
 OVERALL LENGTH = 317" APPROX.
 MODULE LENGTH = 191"

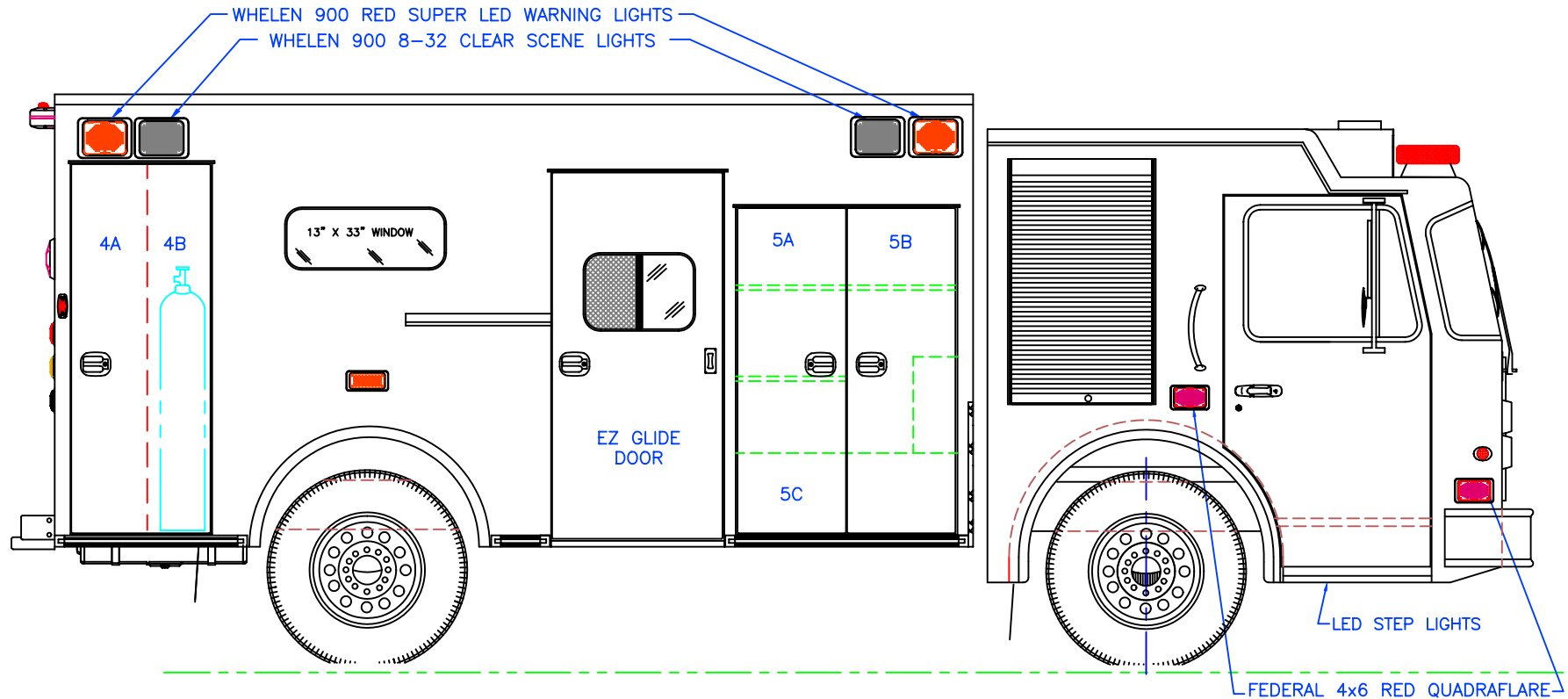

COMPARTMENT

O.S.S #4

CLEAR OPENING: 75.50h x 25.25w
 INSIDE DIM'S. 4A: 76.50h x 16.00w x 21.75d
 BACKBOARD/SCOOP STORAGE

INSIDE DIM'S. 4B: 76.50h x 13.50w x 13.00d
 OXYGEN CYLINDER STORAGE

O.S.S #5

CLEAR OPENING: 66.50h x 41.13w
 INSIDE DIM'S. 5A: 49.50h x 24.50w x 28.50d
 INSIDE/OUTSIDE STORAGE WITH TWO (2) ADJUSTABLE SHELVES

INSIDE DIM'S. 5B: 49.50h x 24.50w x 28.50d
 ADJUSTABLE SHELF, TRANSVERSE BACKBOARD STORAGE

INSIDE DIM'S. 5C 16.25h x 46.00w x 16.50d

CAB ROLL-UP COMPARTMENT
 CLEAR OPENING: 51.00h x 30.00w
 TRANSVERSE COMPARTMENT

DIMENSIONS ARE NOMINAL



2010 CURBSIDE EXTERIOR VIEW
 SUPER CHIEF METRO

1:30

| | |
|-------------------|------------|
| DATE: 4 JAN 10 | |
| DWG. TKD | REV. NR |

DRAWING NO.
MSSC-4

COMPARTMENTS: #1/#2, #3, AND #4 HAVE RESTOCKING FRAMES

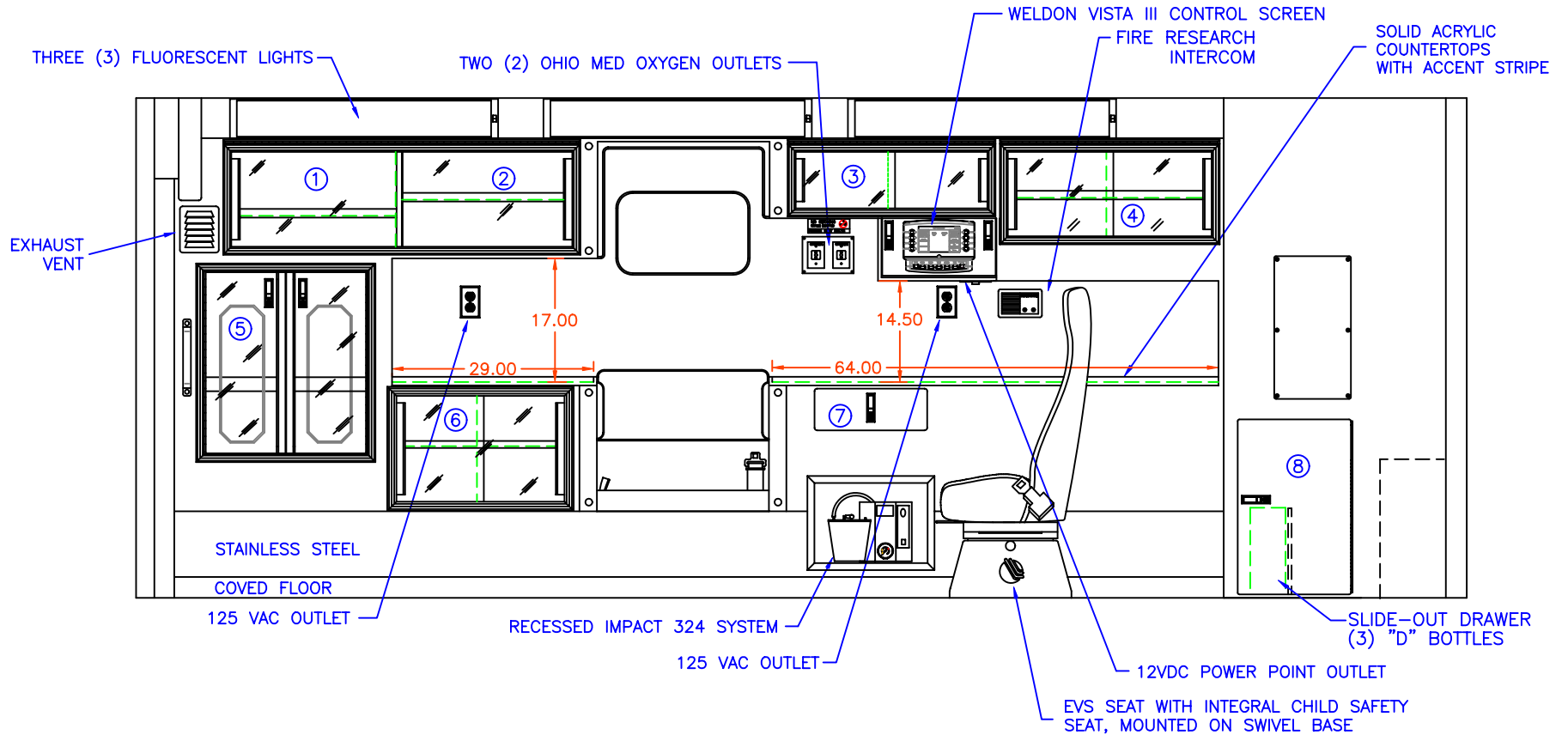

COMPARTMENT

- #1,#2 DOOR OPENING: 13.50h x 49.00w
INSIDE DIMS: 16.00h x 51.00w x 19.50d
PERMANENT DIVIDER; ONE (1) ADJUSTABLE SHELF EA. SIDE
- #3 DOOR OPENING: 7.75h x 27.50w
INSIDE DIMS: 10.25h x 29.50w x 19.50d
- #4 DOOR OPENING: 12.00h x 29.25w
INSIDE DIMS: 19.00h x 31.25w x 19.50d
ONE (1) ADJUSTABLE SHELF

- #5 DOOR OPENING: 26.25h x 23.50w
INSIDE DIMS: O.S.S. #3
RECESSED .375" ACRYLIC DOORS WITH FULL LENGTH HANDLES
TWO (2) LOCKING LEVER LATCHES
- #6 DOOR OPENING: 15.00h x 24.00w
INSIDE DIMS: 16.75h x 28.25w x 18.50d
ONE (1) ADJUSTABLE SHELF
- #7 PULL-OUT DRAWER WITH HINGED ACRYLIC WRITING SURFACE
INSIDE DIMS: 5.00h x 14.50w x 13.25d
LOCKING LEVER LATCH
- #8 DOOR OPENING: 24.50h x 15.75w
INSIDE DIMS: 25.00h x 18.75w x 14.50d
ALUMINUM DOOR, LOCKING LEVER LATCH

DIMENSIONS ARE NOMINAL



2010 STREETSIDE INTERIOR VIEW
SUPER CHIEF METRO

1:22

| | |
|-------|----------|
| DATE: | 9 JAN 10 |
| DWG.: | TKD |
| REV.: | NR |

| | |
|-------------|--------|
| DRAWING NO. | MSSC-5 |
|-------------|--------|

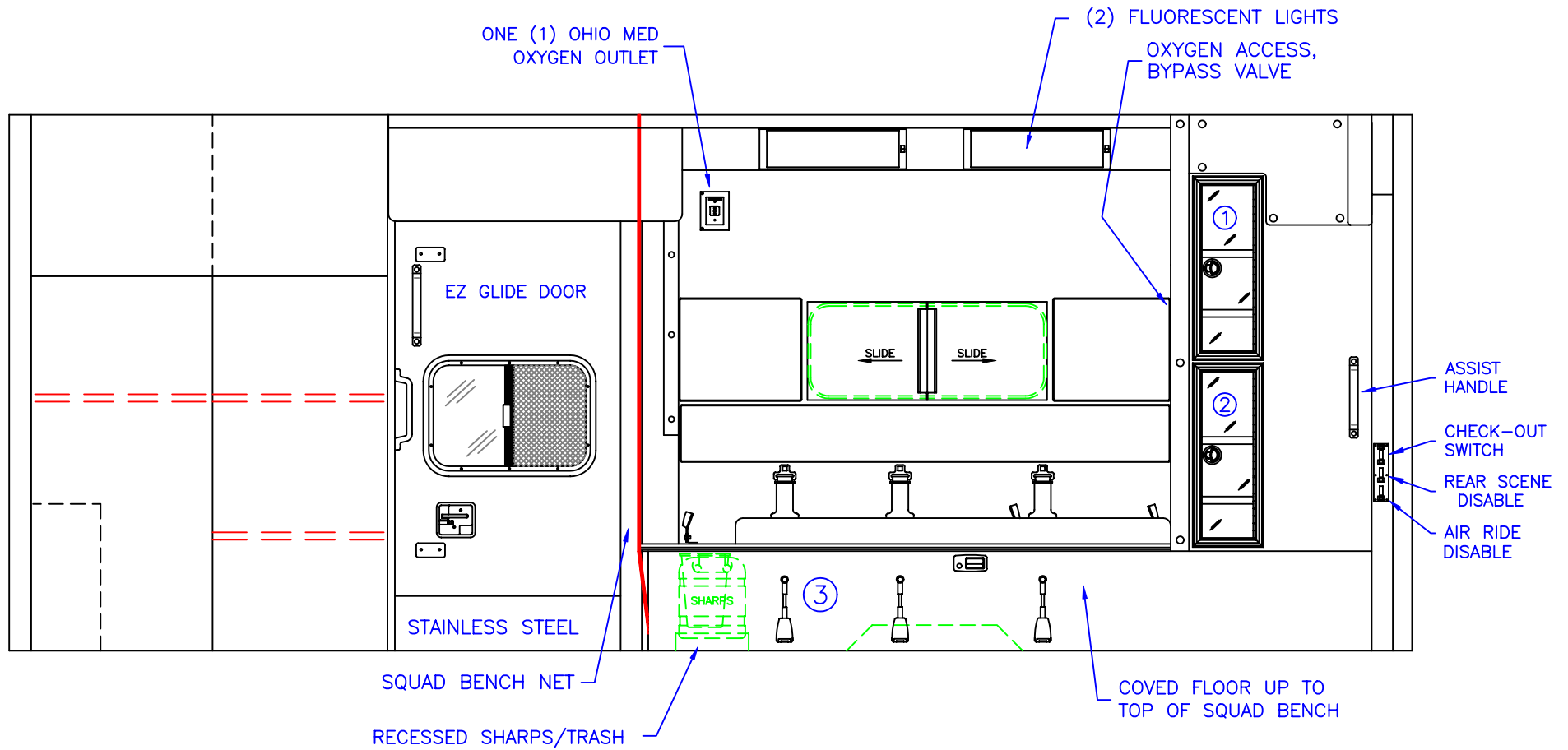

COMPARTMENT

- #1-#2 DOOR OPENINGS: 22.75h x 7.25w
- INSIDE DIMS: 26.00h x 13.25w x 7.50d
- RECESSED .375" ACRYLIC DOORS
- ONE (1) FLUSH PULL LATCH PER DOOR
- TWO (2) ADJUSTABLE SHELVES PER CABINET
- #3 INSIDE DIM'S: 14.25h x 71.75w x 21.00d

DIMENSIONS ARE NOMINAL



2010 CURBSIDE INTERIOR VIEW
SUPER CHIEF METRO

| | | |
|-------------------|------------|-------------|
| DATE: 9 JAN 10 | | DRAWING NO. |
| DWG. TKD | REV. NR | MSSC-6 |

1:20

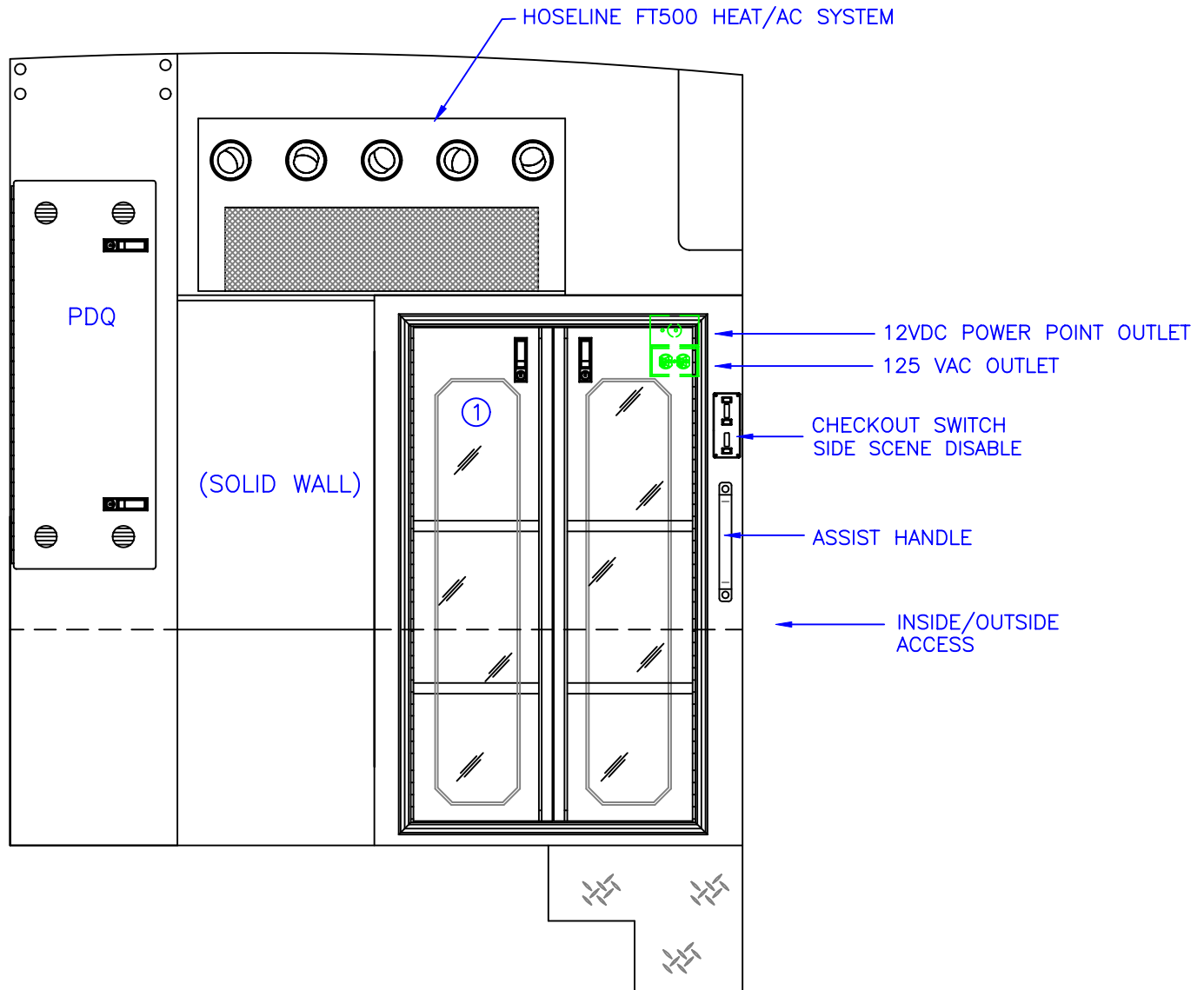

COMPARTMENT

- #1 DOOR OPENING: 46.00h x 26.25w
- INSIDE DIMS: 50.00h x 30.25w x 28.00d
- RECESSED .375" ACRYLIC DOORS WITH FULL LENGTH HANDLES
- TWO (2) LOCKING LEVER LATCHES
- TWO (2) ADJUSTABLE SHELVES

DIMENSIONS ARE NOMINAL



2010 PARTITION INTERIOR VIEW
SUPER CHIEF METRO

| | | | |
|-------------------|------------|-------------|--|
| DATE: 9 JAN 10 | | DRAWING NO. | |
| DWG. TKD | REV. NR | MSSC-7 | |
| 1:14 | | | |

BATTERY POWERED CLOCK

RECESSED 3-GLOVE BOX HOLDER

OXYGEN BYPASS

OXYGEN ACCESS

SQUAD BENCH NET

STAINLESS STEEL

STAINLESS STEEL

RED/WHITE REFLECTIVE STRIP
ON INSIDE OF EACH DOOR

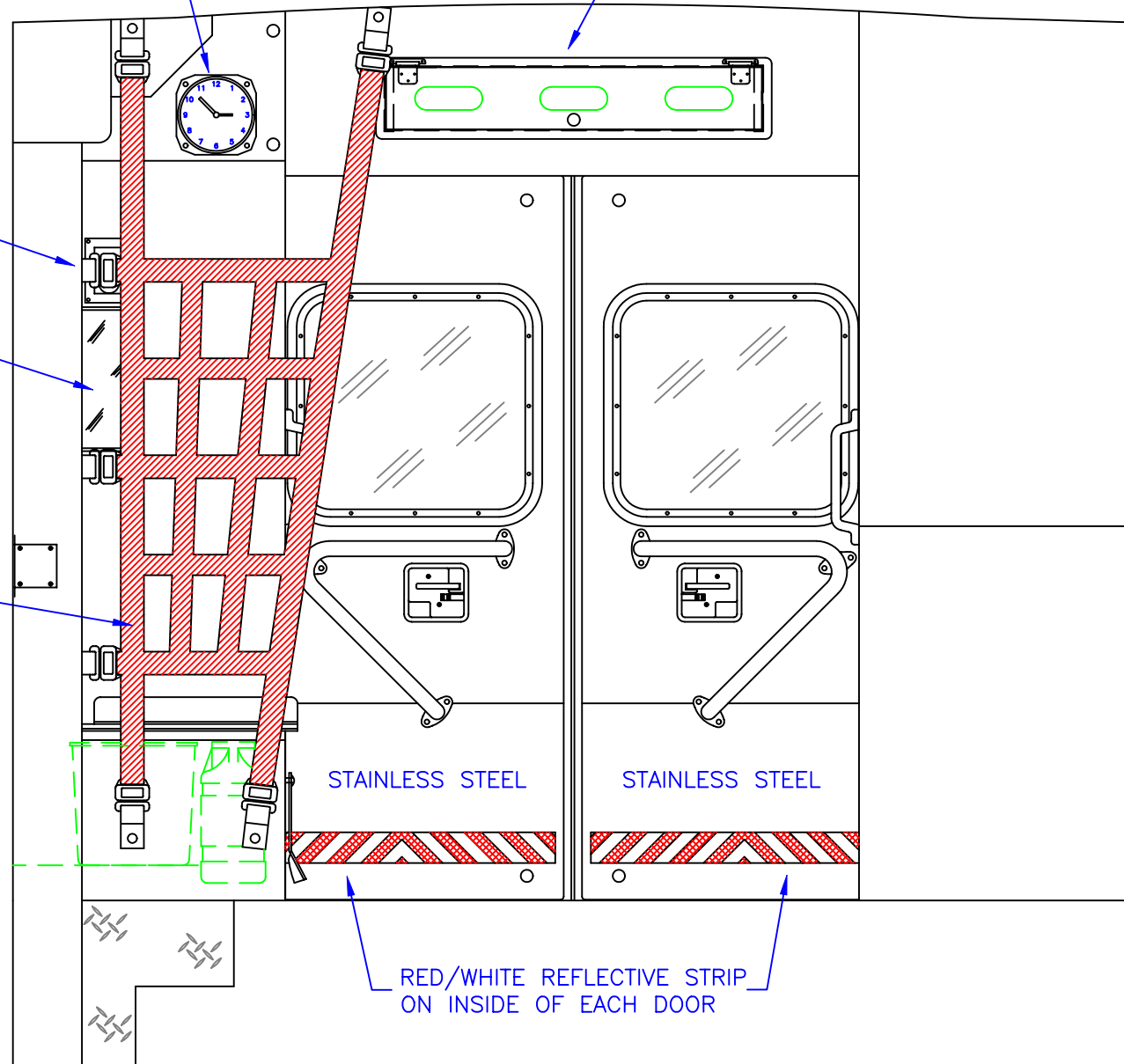

2010 REAR INTERIOR VIEW
SUPER CHIEF METRO

| | | | |
|-------|----------|-------------|--------|
| DATE: | 9 JAN 10 | DRAWING NO. | MSSC-8 |
| DWG. | TKD | REV. | NR |
| 1:14 | | | |

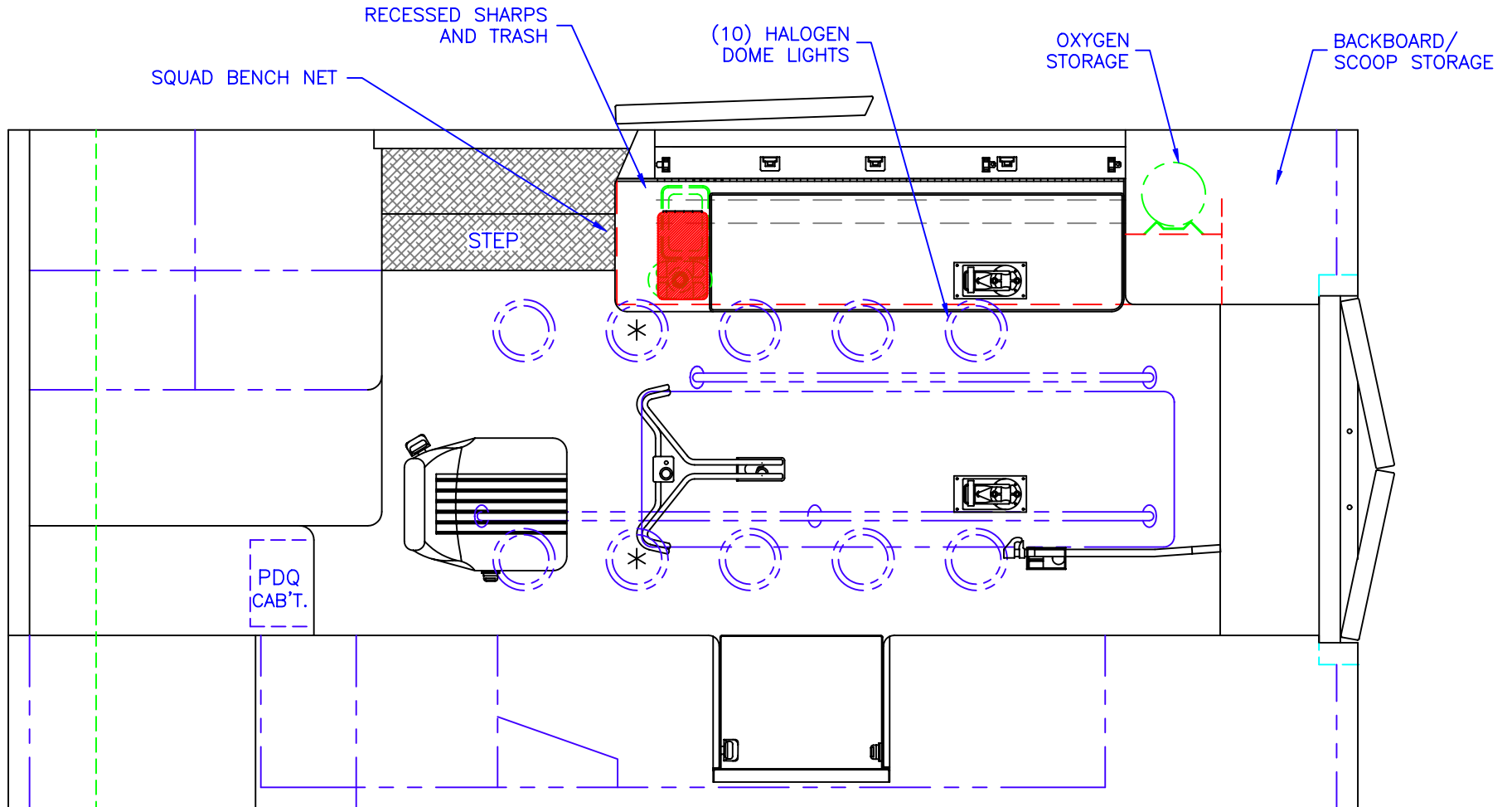

* TWO (2) ANTENNA BASES LOCATED OUTBOARD OF DOME LIGHTS WITH COAX SERVICE LOOP

 TWO (2) RECESSED CEILING IV HANGER LOCATIONS

STRYKER CENTER MOUNT COT HARDWARE

MODULE WIDTH = 96"

MODULE LENGTH = 191"

MODULE HEAD ROOM = 73.5"

DIMENSIONS ARE NOMINAL